

HYDRAULIC MOTORS MP

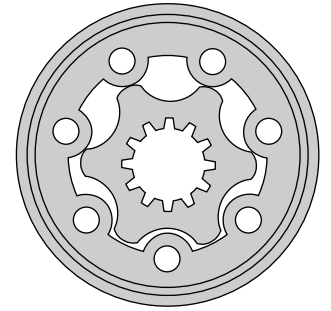

APPLICATION

- » Conveyors
- » Feeding mechanism of robots and manipulators
- » Metal working machines
- » Textile machines
- » Machines for agriculture
- » Food industries
- » Grass cutting machinery etc.



CONTENTS

Specification data	13 ÷ 14
Function diagrams	15 ÷ 21
Dimensions and mounting	22
Wheel motor	23
Shaft extensions	24
Permissible shaft loads	25
Permissible shaft Seal Pressure ...	26
Order code	27

OPTIONS

- » Model- Spool valve, gerotor
- » Flange and wheel mount
- » Motor with needle bearing
- » Side and rear ports
- » Shafts- straight, splined and tapered
- » Shaft seal for high and low pressure
- » Metric and BSPP ports
- » Speed sensing
- » Other special features

GENERAL

Displacement,	[cm ³ /rev.]	25 ÷ 623,6
Max. Speed,	[RPM]	95 ÷ 1600
Max. Torque,	[daNm]	3,3 ÷ 50
Max. Output,	[kW]	3,3 ÷ 10,5
Max. Pressure Drop,	[bar]	55 ÷ 140
Max. Oil Flow,	[l/min]	40 ÷ 60
Min. Speed,	[RPM]	10
Pressure fluid		Mineral based- HLP(DIN 51524) or HM(ISO 6743/4)
Temperature range,	[°C]	-30 ÷ 90
Optimal Viscosity range,	[mm ² /s]	20 ÷ 75
Filtration		ISO code 20/16 (Min. recommended fluid filtration of 25 micron)

Oil flow in drain line

Pressure drop (bar)	Viscosity (mm ² /s)	Oil flow in drain line (l/min)
100	20	2,5
	35	1,8
140	20	3,5
	35	2,8

Pressure Losses

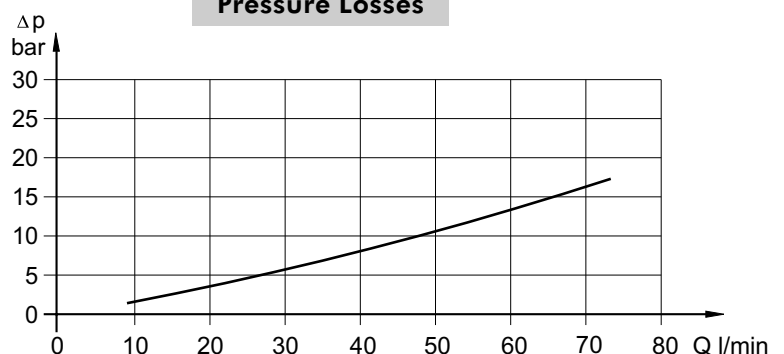

MP
MOTORS

SPECIFICATION DATA

Specification Data for MP... motors with C, CO, SH, K and SA shafts.
(ø28,56 sealing diameter)

Type	MP													
	25	32	40	50	80	100	125	160	200	250	315	400	500	630
Displacement, [cm ³ /rev.]	25	32	40	49,5	79,2	99	123,8	158,4	198	247,5	316,8	396	495	623,6
Max. Speed, [RPM]	cont.	1600	1560	1500	1210	755	605	486	378	303	242	190	150	95
	int.*	1800	1720	1750	1515	945	755	605	472	378	303	236	189	120
Max. Torque [daNm]	cont.	3,3	4,3	6,2	9,4	15,1	19,3	23,7	31,3	36,6	38	38	36	39
	int.*	4,7	6,1	8,2	11,9	19,5	23,7	29,8	37,8	45,6	58,3	56	59	64
	peak**	6,7	8,6	10,7	14,3	22,4	27,5	36,5	43,8	55	68,5	85	85,4	78
Max. Output, [kW]	cont.	4,5	5,8	8,4	10,1	10,2	10,5	10	10,1	10	7,5	5,7	4,6	3,5
	int.*	6,1	7,8	11,6	12,2	12,5	12,8	12	12,1	12	12	9	7,8	7,2
Max. Pressure Drop [bar]	cont.	100	100	120	140	140	140	140	140	140	110	90	70	60
	int.*	140	140	155	175	175	175	175	175	175	175	140	115	90
	peak**	225	225	225	225	225	225	225	225	225	225	225	180	130
Max. Oil Flow [l/min]	cont.	40	50	60	60	60	60	60	60	60	60	60	60	60
	int.*	45	55	70	70	70	70	70	70	70	70	70	70	70
Max. Inlet Pressure [bar]	cont.	175	175	175	175	175	175	175	175	175	175	175	140	140
	int.*	200	200	200	200	200	200	200	200	200	200	200	175	175
	peak**	225	225	225	225	225	225	225	225	225	225	225	225	225
Max. Return Pressure with Drain Line [bar]	cont.	175	175	175	175	175	175	175	175	175	175	175	140	140
	int.*	200	200	200	200	200	200	200	200	200	200	200	175	175
	peak**	225	225	225	225	225	225	225	225	225	225	225	225	225
Max. Starting Pressure with Unloaded Shaft, [bar]		10	10	10	10	10	10	9	8	7	6	5	5	5
Min. Starting Torque [daNm]	at max. press. drop cont.	3	4	5,4	7,8	13,2	16,6	20,7	28,2	33,5	33,6	34,4	34,5	36
	at max. press. drop int.*	4,2	5,6	6,9	10	16,8	21	26,6	35,5	42,6	54,2	61,9	60,8	54
Min. Speed***, [RPM]		20	15	10	10	10	10	10	10	10	10	10	10	10
Weight, avg. [kg]	MP(F)	5,6	5,6	5,7	5,8	5,9	6,1	6,2	6,4	6,6	6,8	7,1	7,6	8,9
	MPQ(N)	5,0	5,0	5,1	5,2	5,3	5,5	5,6	5,8	6,0	6,2	6,5	6,8	8,3
	MP(F)(N)E	6,1	6,1	6,2	6,3	6,4	6,6	6,7	6,9	7,1	7,3	7,6	8,1	9,3
	MPW(N)	5,3	5,3	5,4	5,5	5,6	5,8	5,9	6,1	6,3	6,5	6,8	7,2	8,6
	MPQ(N)E	5,5	5,5	5,6	5,7	5,8	6,0	6,1	6,3	6,5	6,7	7,0	7,3	8,8

* Intermittent operation: the permissible values may occur for max. 10% of every minute.

** Peak load: the permissible values may occur for max. 1% of every minute.

*** For speeds of 10 RPM or lower, consult factory or your regional manager.

- Intermittent speed and intermittent pressure drop must not occur simultaneously.
- Recommended filtration is per ISO cleanliness code 20/16. A nominal filtration of 25 micron or better.
- Recommended using a premium quality, anti-wear type mineral based hydraulic oil HLP(DIN51524) or HM (ISO 6743/4).
If using synthetic fluids consult the factory for alternative seal materials.
- Recommended minimum oil viscosity 13 mm²/s at operating temperatures.
- Recommended maximum system operating temperature is 82°C.
- To assure optimum motor life fill with fluid prior to loading and run at moderate load and speed for 10-15 minutes.

MP
MOTORS

SPECIFICATION DATA (continued)

Specification Data for MP... motors with CB, KB, OB and HB shafts.
(ø35 sealing diameter)

Type	MP													
	25	32	40	50	80	100	125	160	200	250	315	400	500	630
Displacement, [cm ³ /rev.]	25	32	40	49,5	79,2	99	123,8	158,4	198	247,5	316,8	396	495	623,6
Max. Speed, [RPM]	cont.	1600	1560	1500	1210	755	605	486	378	303	242	190	150	95
	int.*	1800	1720	1750	1515	945	755	605	472	378	303	236	189	120
Max. Torque [daNm]	cont.	3,3	4,3	6,2	9,4	15,1	19,3	23,7	31,3	36,6	47	48,6	50	39
	int.*	4,7	6,1	8,2	11,9	19,5	23,7	29,8	37,8	45,6	58,3	56	59	64
	peak**	6,7	8,6	10,7	14,3	22,4	27,5	36,5	43,8	55	68,5	85	85,4	78
Max. Output, [kW]	cont.	4,5	5,8	8,4	10,1	10,2	10,5	10	10,1	9,5	9,5	7,6	6,2	3,5
	int.*	6,1	7,8	11,6	12,2	12,5	12,8	12	12,1	12,5	12	9	7,8	7,2
Max. Pressure Drop [bar]	cont.	100	100	120	140	140	140	140	140	140	140	120	95	60
	int.*	140	140	155	175	175	175	175	175	175	175	140	115	90
	peak**	225	225	225	225	225	225	225	225	225	225	225	180	130
Max. Oil Flow [l/min]	cont.	40	50	60	60	60	60	60	60	60	60	60	60	60
	int.*	45	55	70	70	70	70	70	70	70	70	70	70	70
Max. Inlet Pressure [bar]	cont.	175	175	175	175	175	175	175	175	175	175	175	140	140
	int.*	200	200	200	200	200	200	200	200	200	200	200	175	175
	peak**	225	225	225	225	225	225	225	225	225	225	225	225	225
Max. Return Pressure with Drain Line [bar]	cont.	175	175	175	175	175	175	175	175	175	175	175	140	140
	int.*	200	200	200	200	200	200	200	200	200	200	200	175	175
	peak**	225	225	225	225	225	225	225	225	225	225	225	225	225
Max. Starting Pressure with Unloaded Shaft, [bar]		10	10	10	10	10	10	9	8	7	6	5	5	5
Min. Starting Torque [daNm]	at max. press. drop cont.	3	4	5,4	7,8	13,2	16,6	20,7	28,2	33,5	42,8	45,8	46,8	36
	at max. press. drop int.*	4,2	5,6	6,9	10	16,8	21	26,6	35,5	42,6	54,2	61,9	60,8	54
Min. Speed***, [RPM]		20	15	10	10	10	10	10	10	10	10	10	10	10
Weight, avg. [kg]	MP(F)...B	5,6	5,6	5,7	5,9	6	6,2	6,3	6,5	6,7	6,9	7,2	7,7	9
	MP(F)E...B	6,1	6,1	6,2	6,4	6,5	6,7	6,8	6,9	7,2	7,4	7,7	8,2	10,1

* Intermittent operation: the permissible values may occur for max. 10% of every minute.

** Peak load: the permissible values may occur for max. 1% of every minute.

*** For speeds of 10 RPM or lower, consult factory or your regional manager.

- Intermittent speed and intermittent pressure drop must not occur simultaneously.
- Recommended filtration is per ISO cleanliness code 20/16. A nominal filtration of 25 micron or better.
- Recommended using a premium quality, anti-wear type mineral based hydraulic oil HLP(DIN51524) or HM (ISO 6743/4).
If using synthetic fluids consult the factory for alternative seal materials.
- Recommended minimum oil viscosity 13 mm²/s at operating temperatures.
- Recommended maximum system operating temperature is 82°C.
- To assure optimum motor life fill with fluid prior to loading and run at moderate load and speed for 10-15 minutes.

FUNCTION DIAGRAMS

MP 25

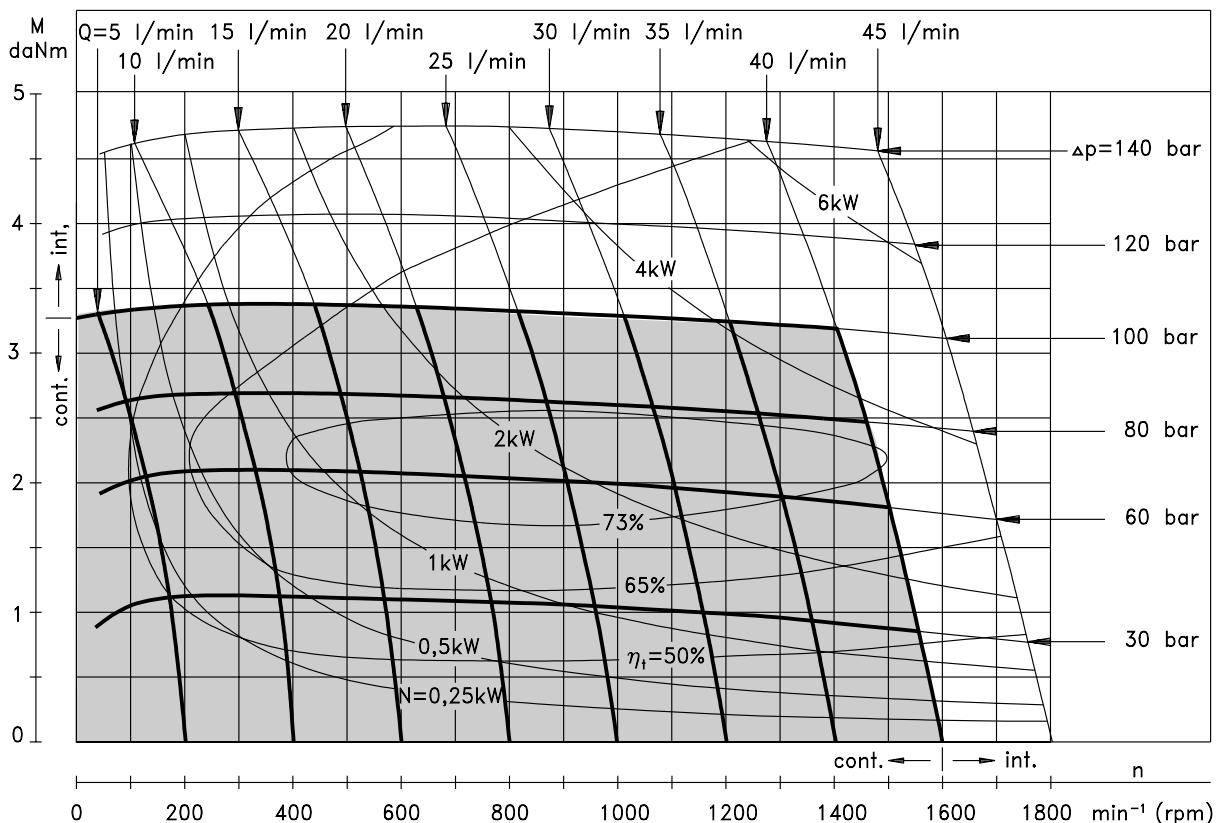

MP 32

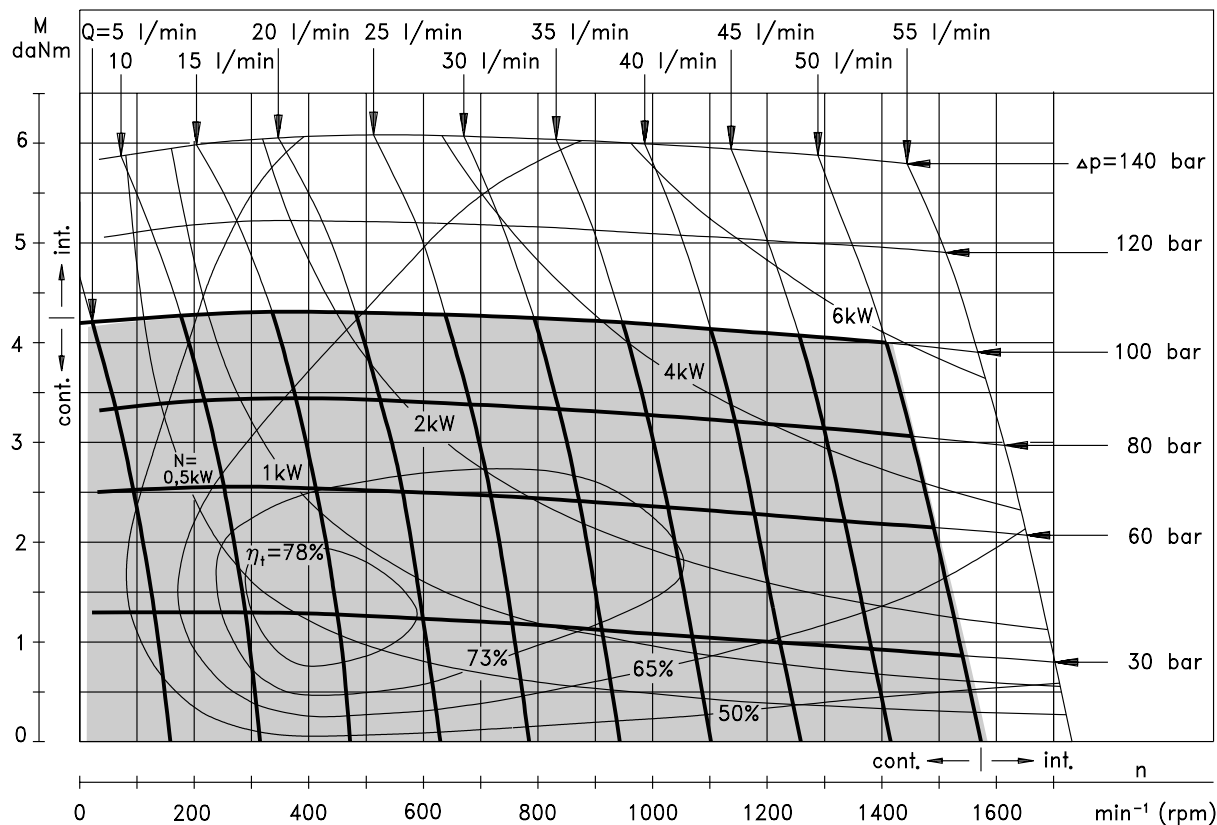

The function diagrams data was collected at back pressure 5 ÷ 10 bar and oil with viscosity of 32 mm²/s at 50° C.

FUNCTION DIAGRAMS

MP 40

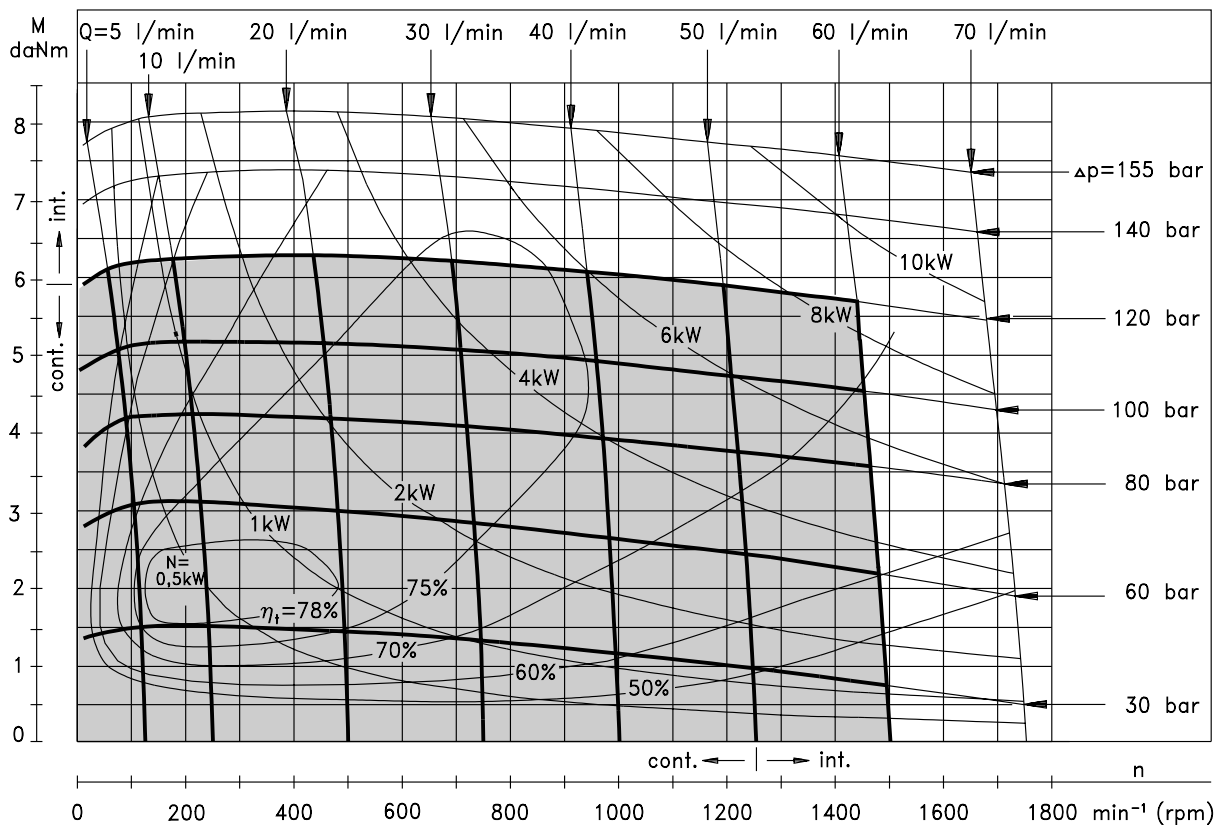

MP 50

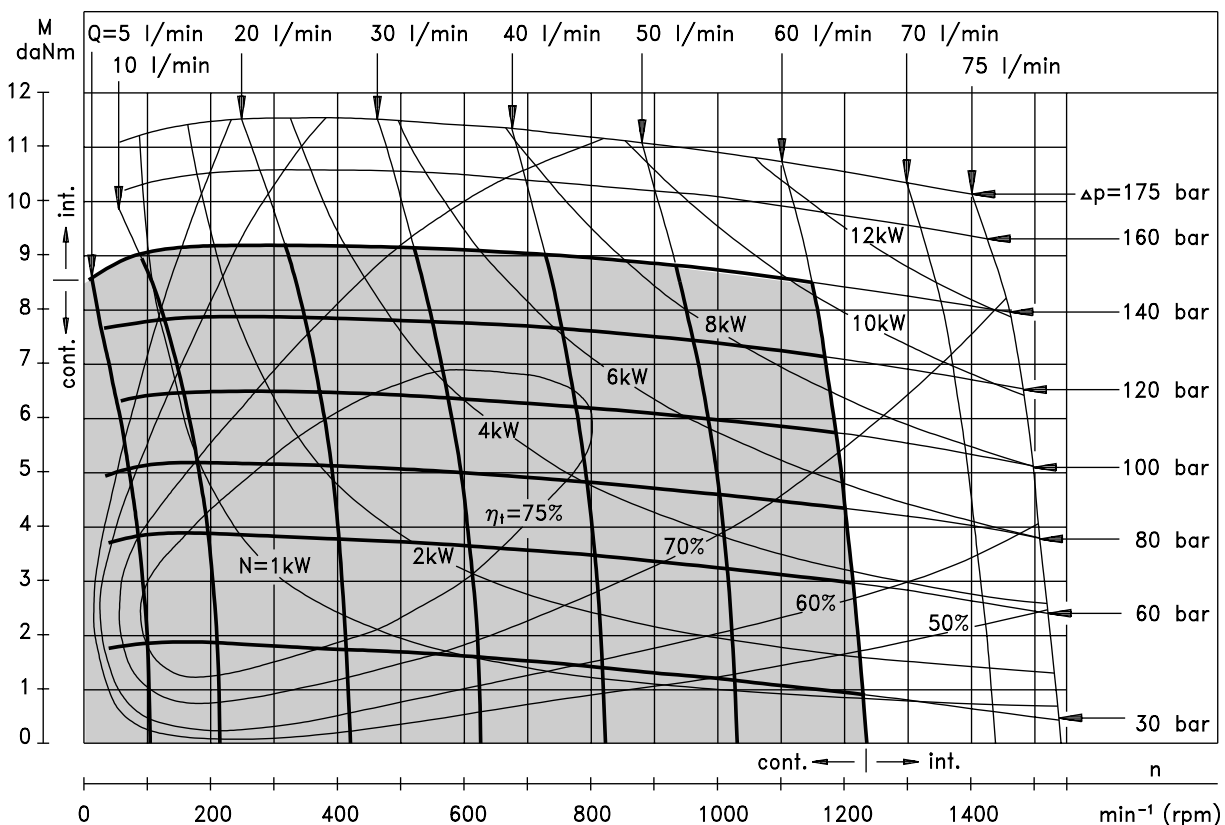

The function diagrams data was collected at back pressure 5 ÷ 10 bar and oil with viscosity of 32 mm²/s at 50° C.

FUNCTION DIAGRAMS

MP 80

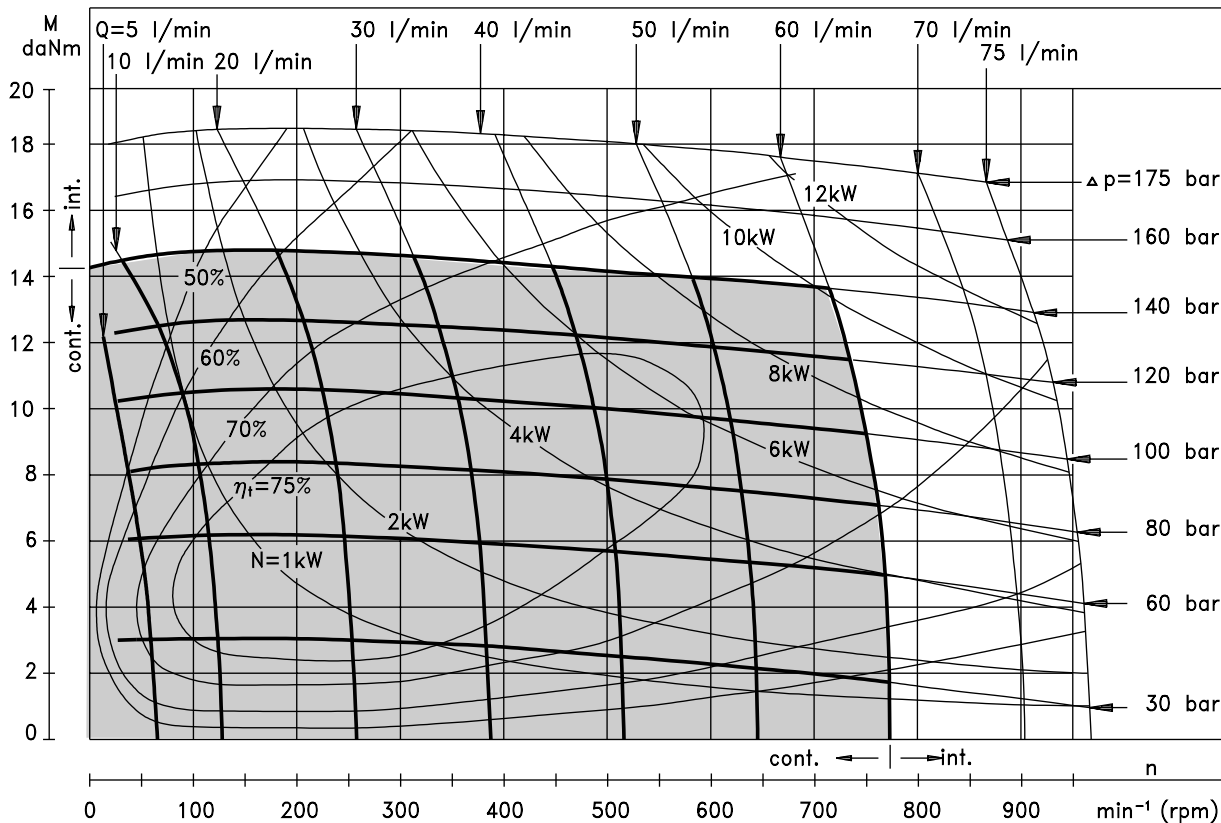

MP 100

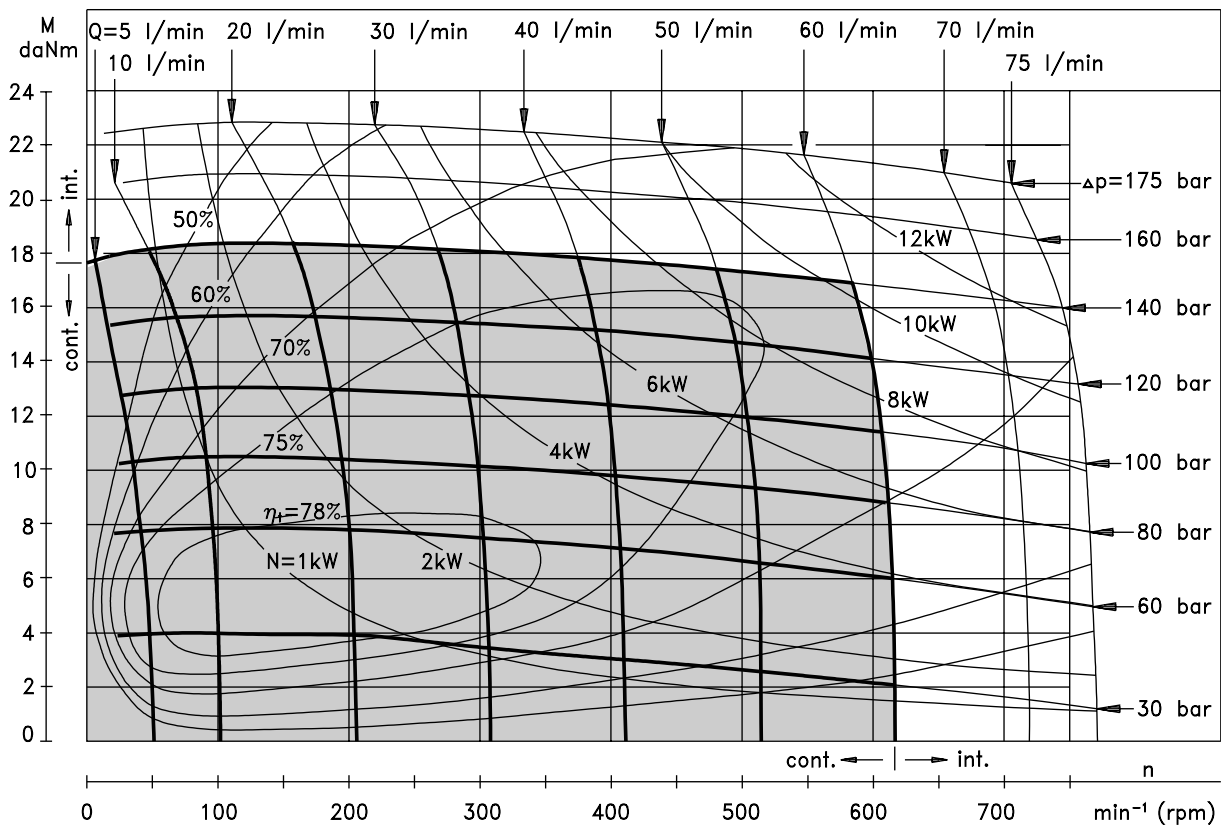

The function diagrams data was collected at back pressure 5 ÷ 10 bar and oil with viscosity of 32 mm²/s at 50 °C.

FUNCTION DIAGRAMS

MP 125

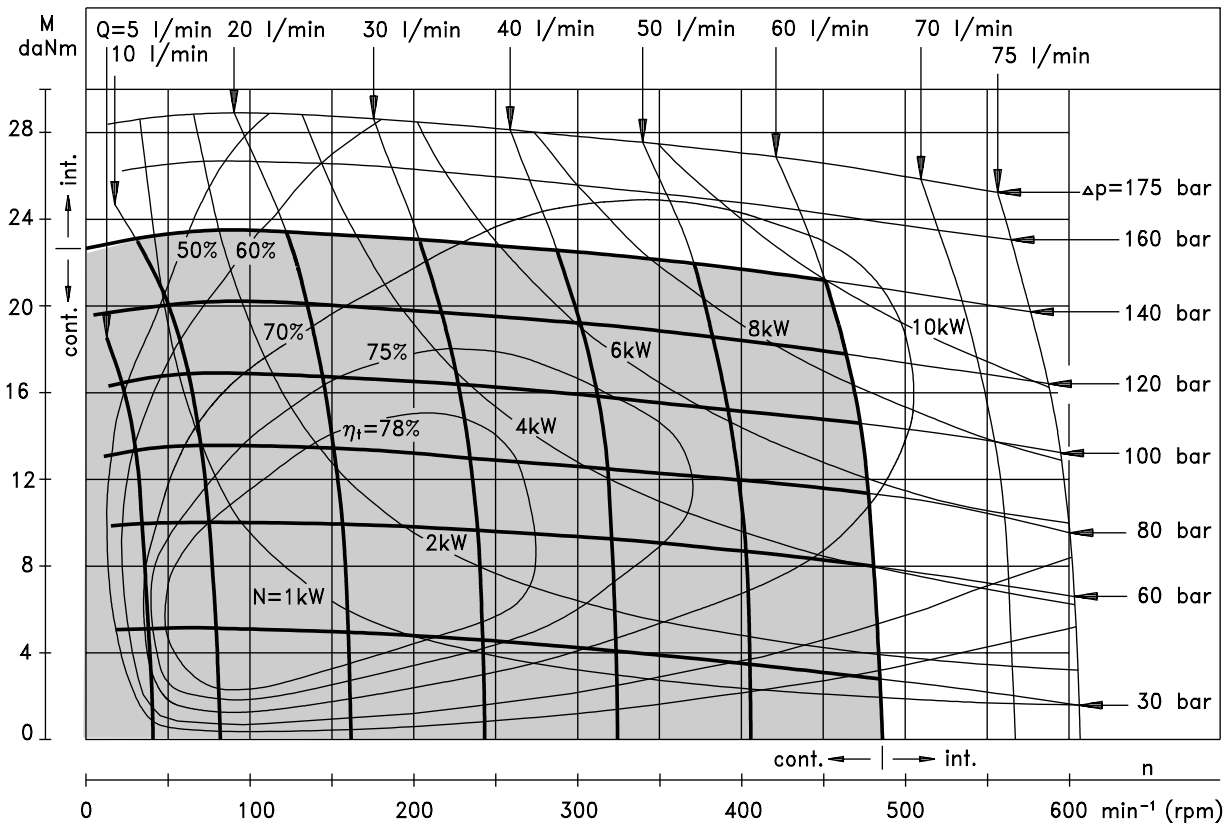

MP 160

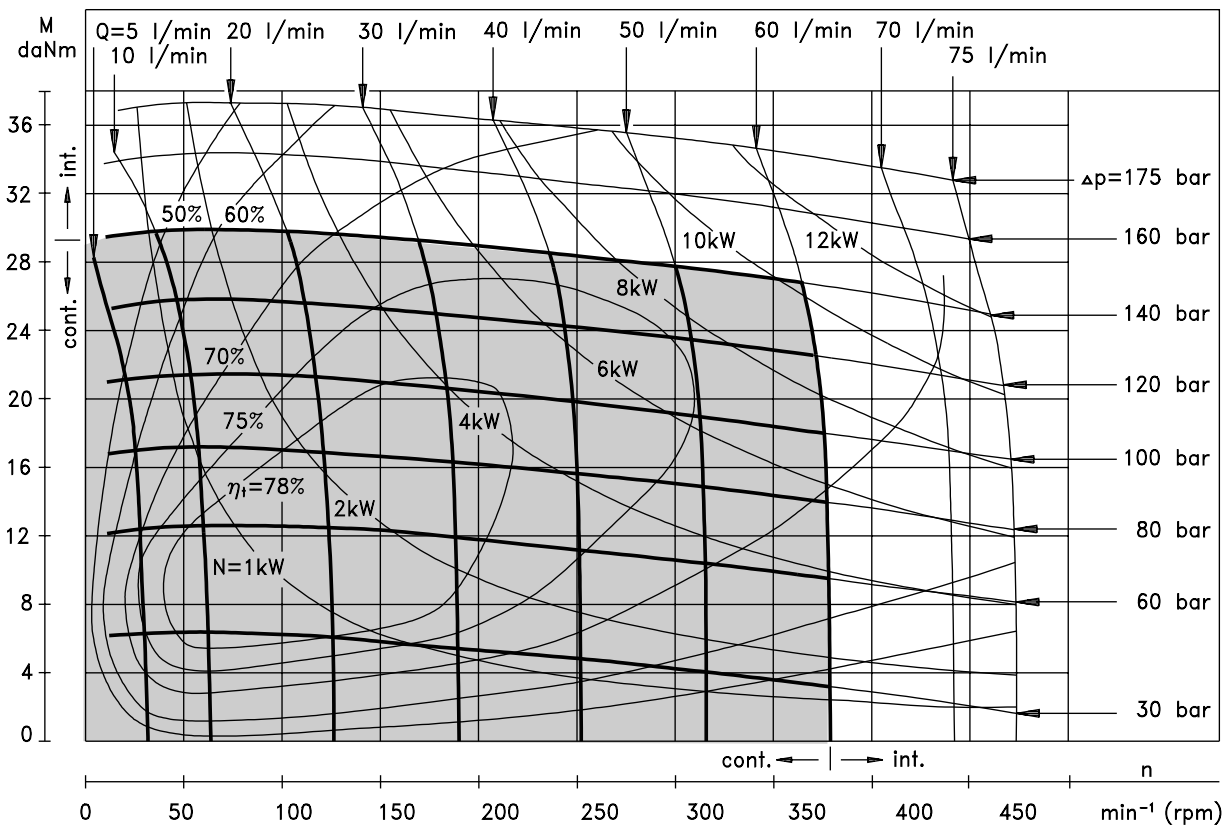

The function diagrams data was collected at back pressure 5 ÷ 10 bar and oil with viscosity of 32 mm²/s at 50° C.

FUNCTION DIAGRAMS

MP 200

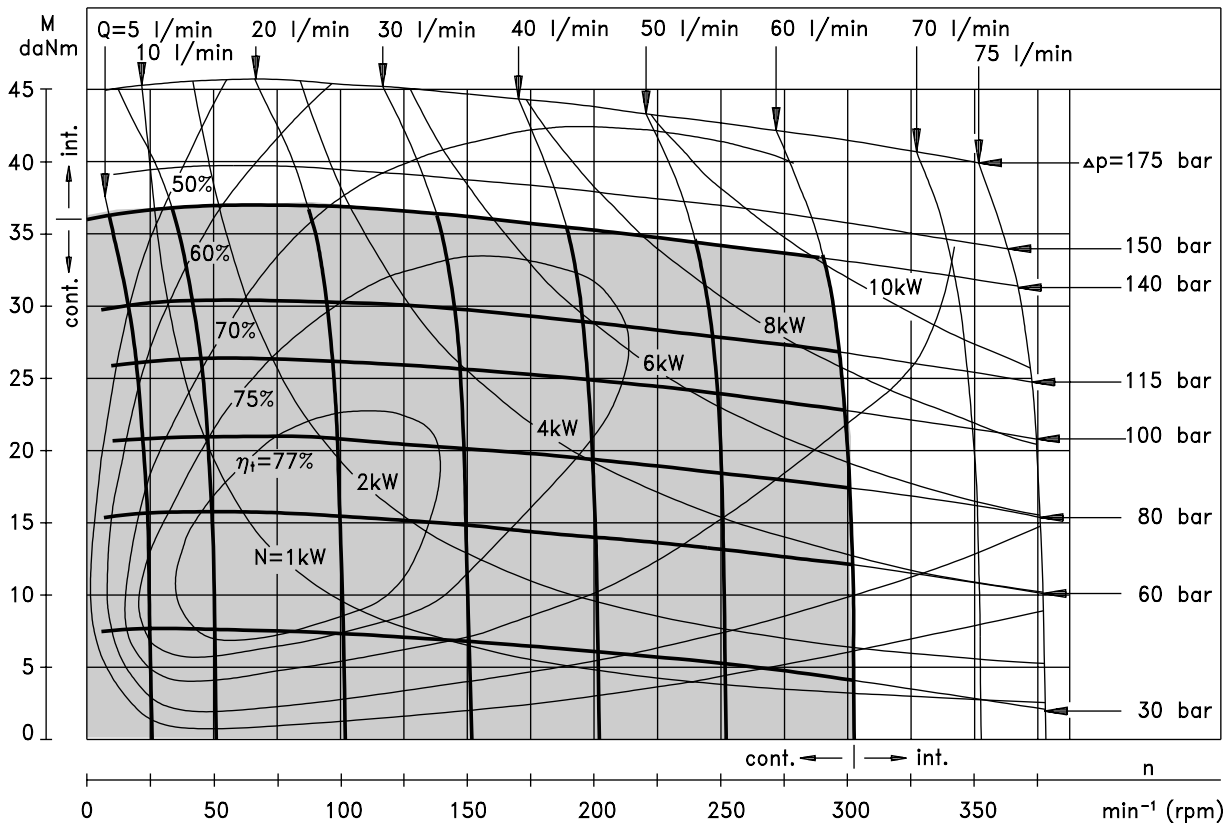

MP 250

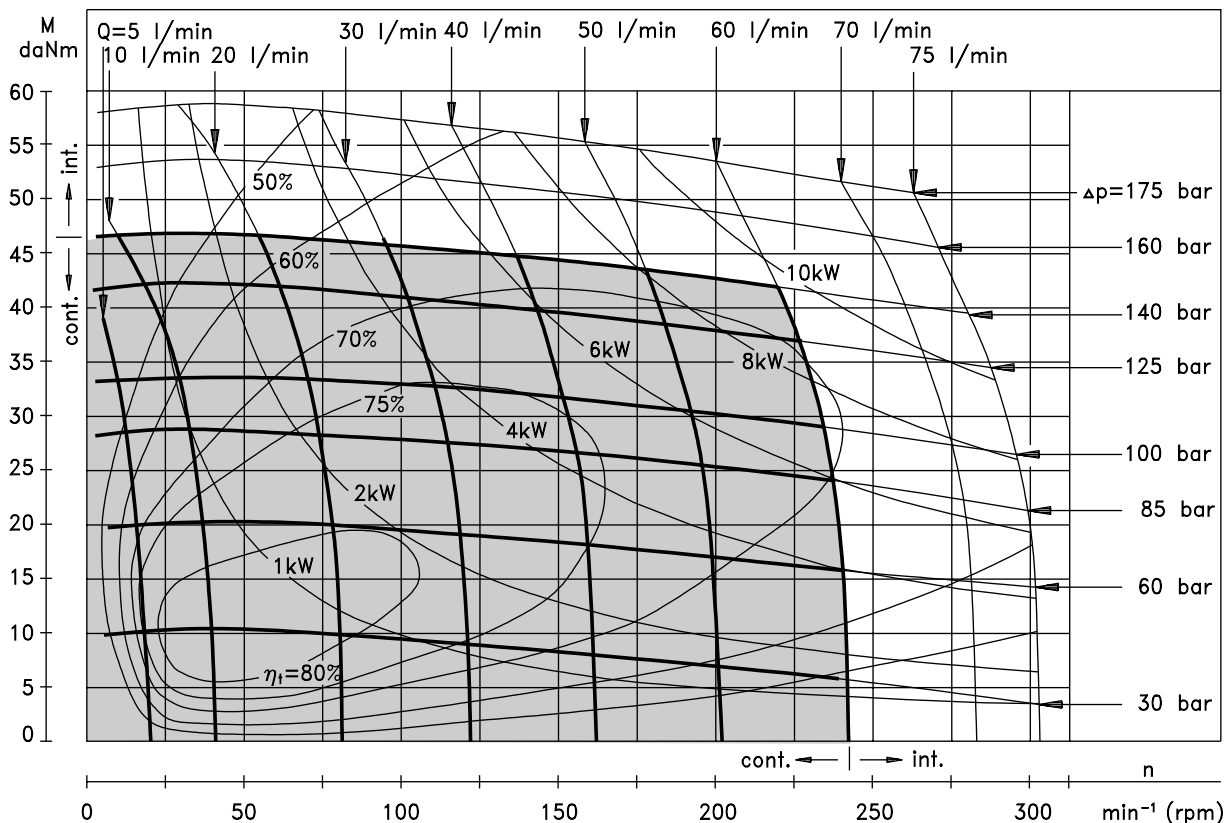

The function diagrams data was collected at back pressure 5 ÷ 10 bar and oil with viscosity of 32 mm²/s at 50° C.

FUNCTION DIAGRAM

MP 315

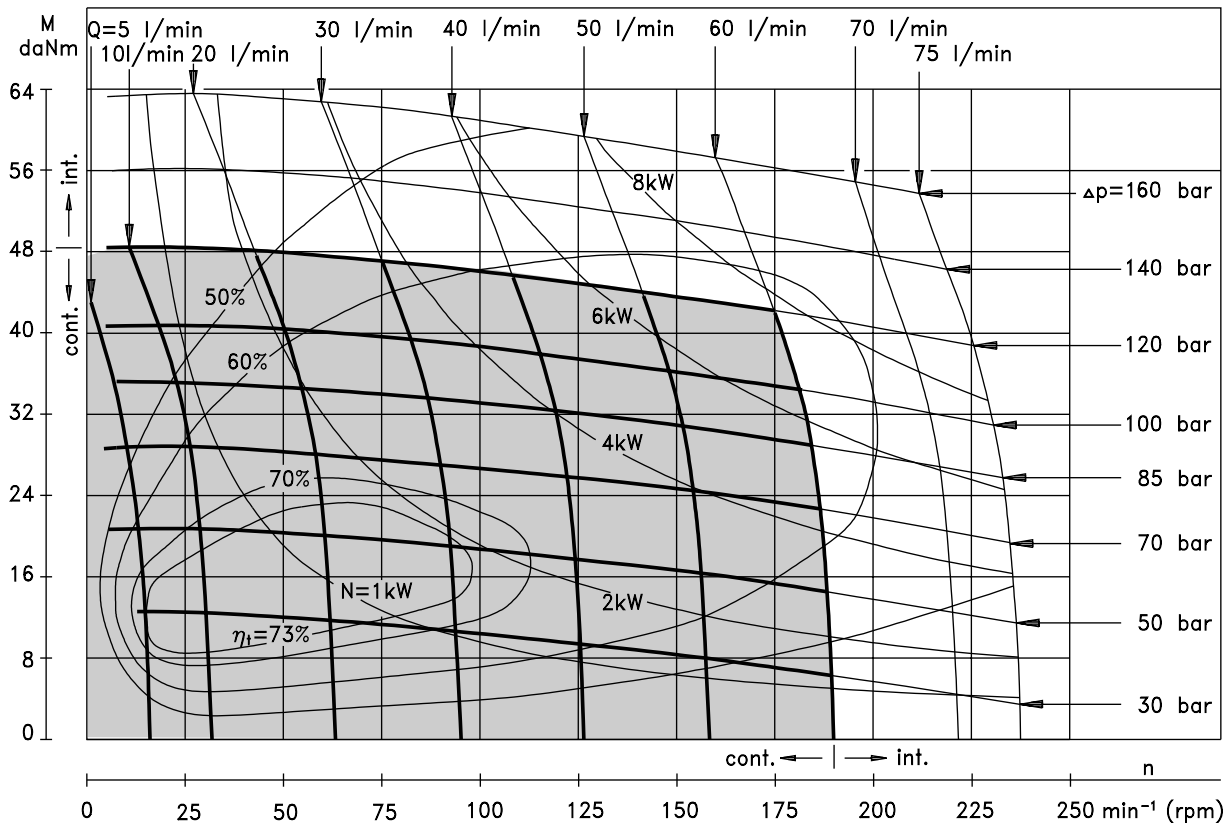

MP 400

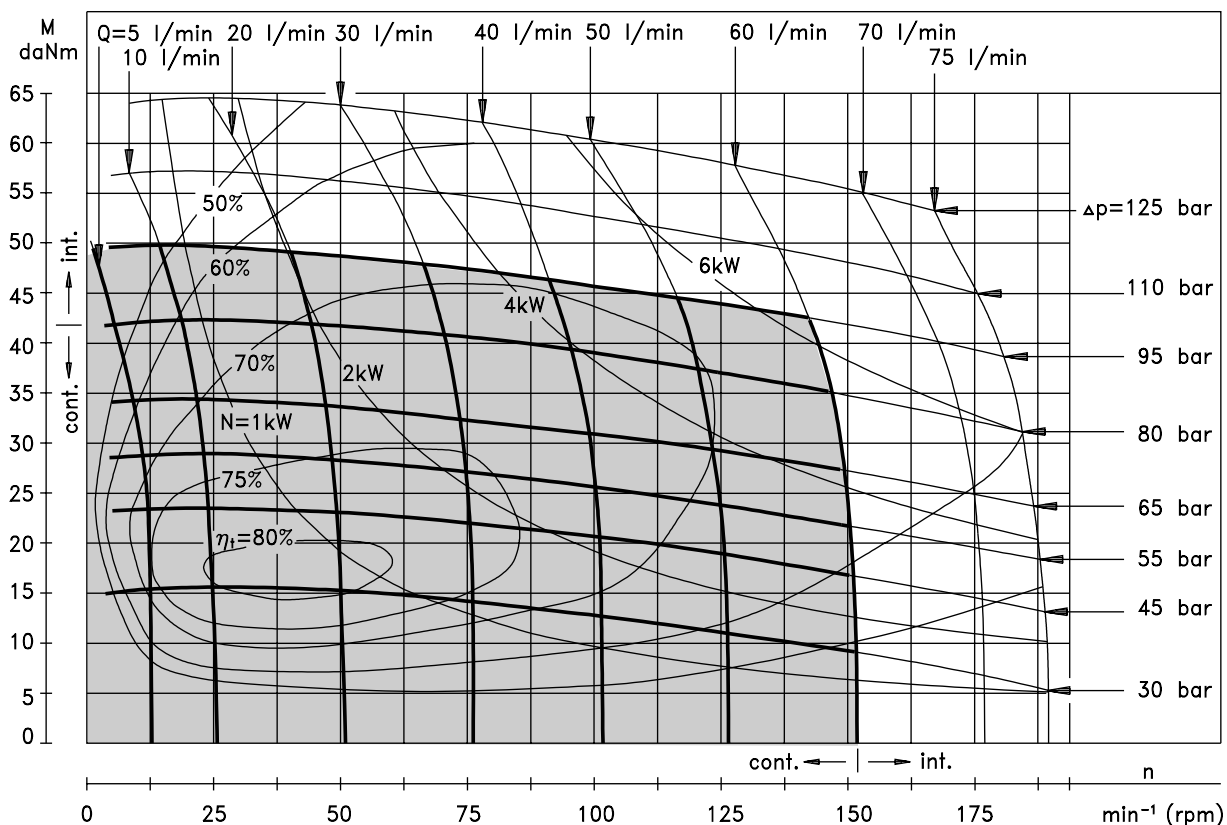

The function diagram data was collected at back pressure 5 ÷ 10 bar and oil with viscosity of 32 mm²/s at 50° C.

FUNCTION DIAGRAM

MP 500

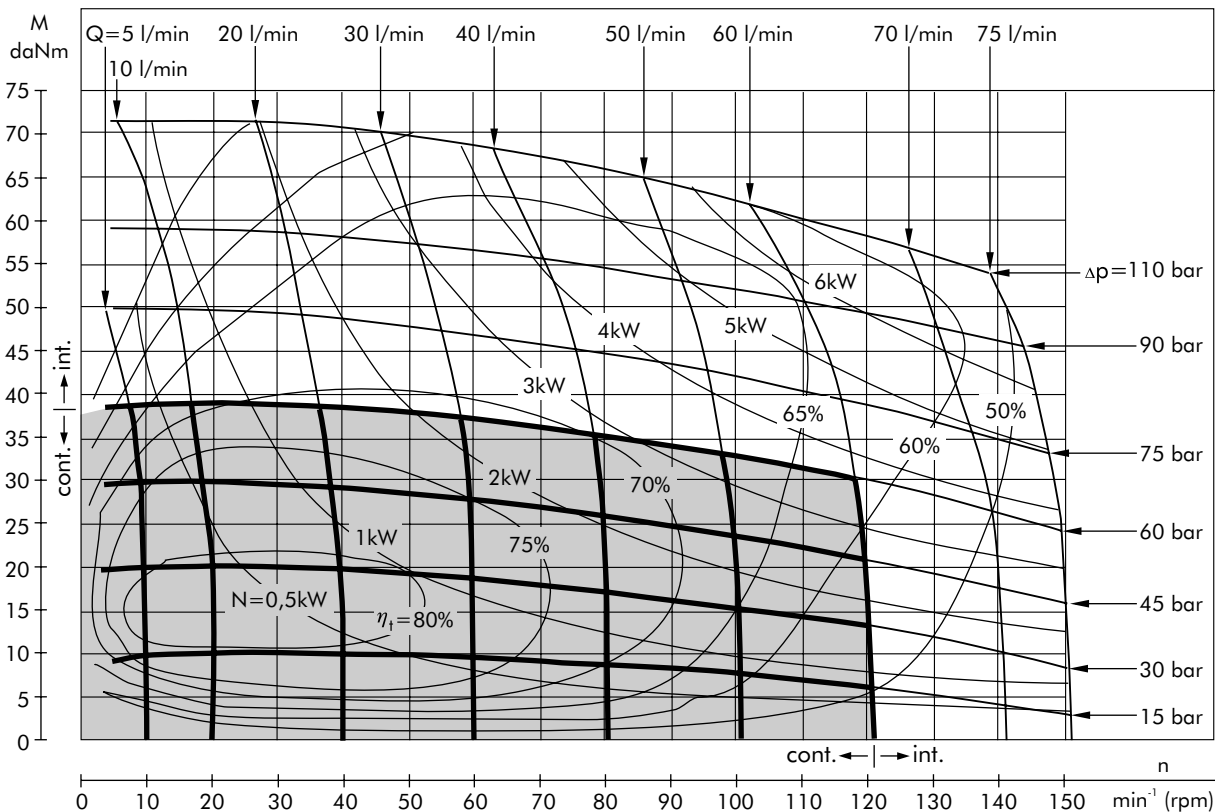

MP 630

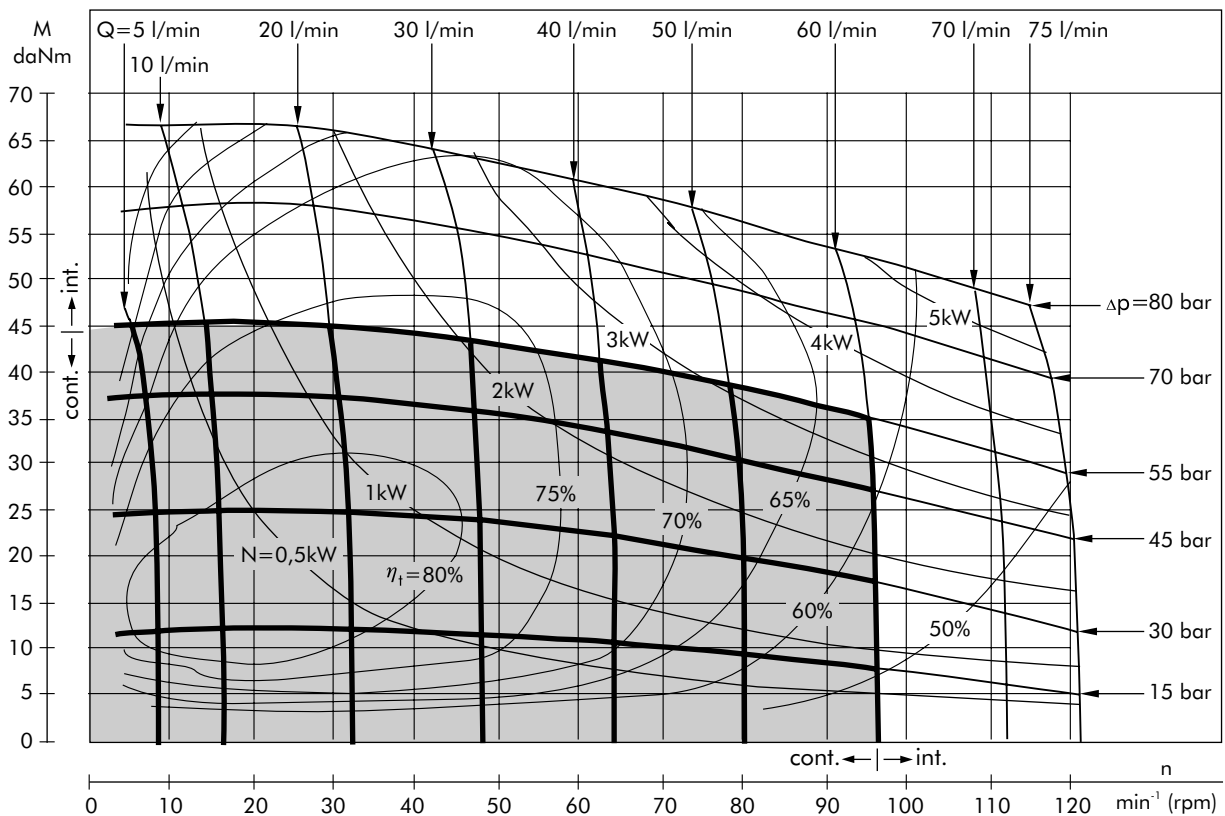

The function diagram data was collected at back pressure 5 ÷ 10 bar and oil with viscosity of 32 mm²/s at 50° C.

DIMENSIONS AND MOUNTING DATA

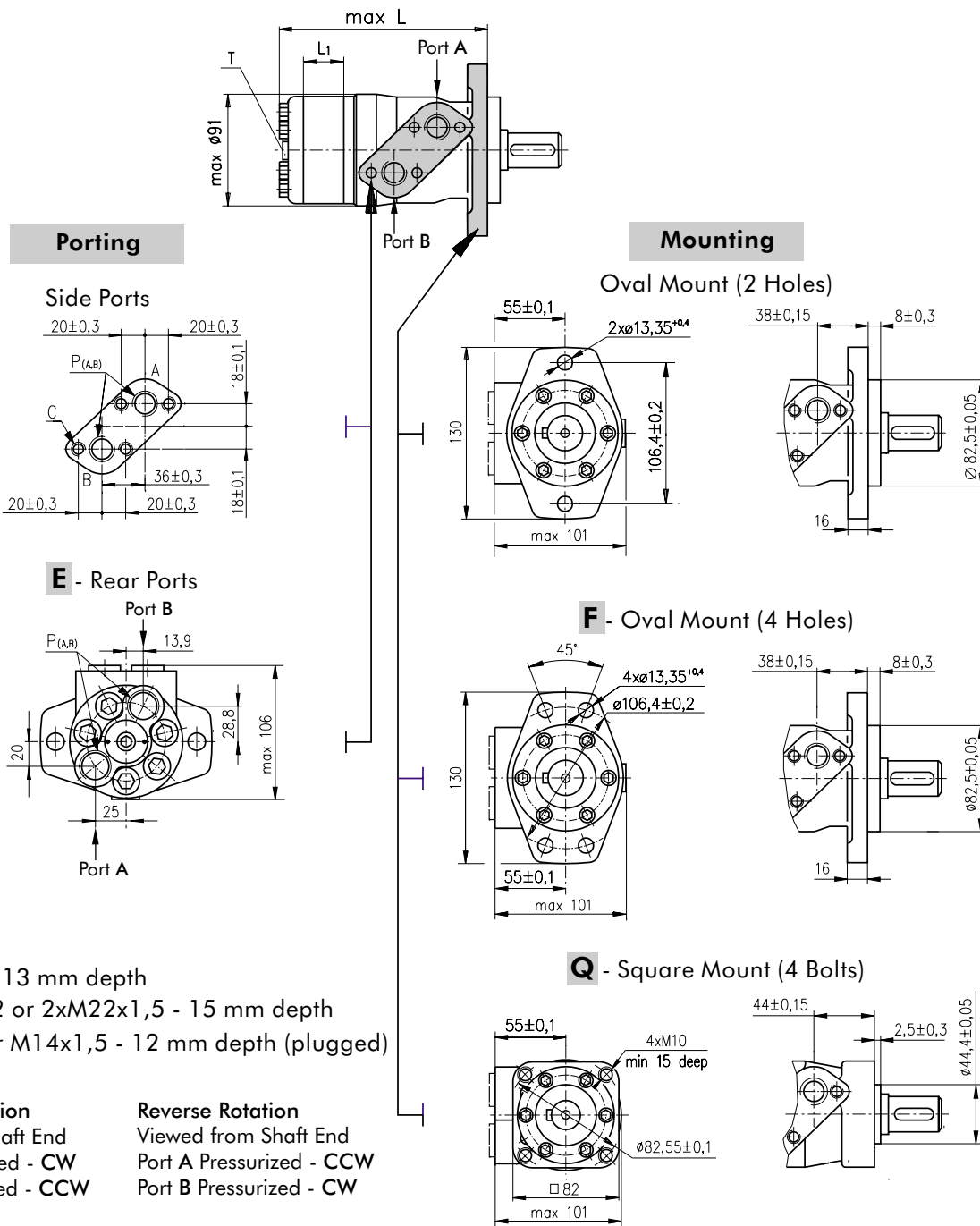

C : 4xM8 - 13 mm depth
P_(A,B): 2xG1/2 or 2xM22x1,5 - 15 mm depth
T : G1/4 or M14x1,5 - 12 mm depth (plugged)

Standard Rotation
 Viewed from Shaft End
 Port A Pressurized - CW
 Port B Pressurized - CCW

Reverse Rotation
 Viewed from Shaft End
 Port A Pressurized - CCW
 Port B Pressurized - CW

Type	L, mm	Type	L, mm	Type	L, mm	Type	L, mm	L ₁ , mm
MP(F) 25	134,0	MPQ 25	140,5	MP(F)E 25	151,5	MPQE 25	158,0	5,20
MP(F) 32	135,0	MPQ 32	141,5	MP(F)E 32	152,5	MPQE 32	159,0	6,30
MP(F) 40	136,5	MPQ 40	142,5	MP(F)E 40	154,0	MPQE 40	160,0	7,40
MP(F) 50	135,5	MPQ 50	142,0	MP(F)E 50	153,0	MPQE 50	159,5	6,67
MP(F) 80	139,5	MPQ 80	146,0	MP(F)E 80	157,0	MPQE 80	163,0	10,67
MP(F) 100	142,0	MPQ 100	148,5	MP(F)E 100	160,0	MPQE 100	166,0	13,33
MP(F) 125	145,5	MPQ 125	152,0	MP(F)E 125	163,0	MPQE 125	169,5	16,67
MP(F) 160	150,0	MPQ 160	156,5	MP(F)E 160	168,0	MPQE 160	174,0	21,33
MP(F) 200	155,5	MPQ 200	162,0	MP(F)E 200	173,0	MPQE 200	179,5	26,67
MP(F) 250	162,0	MPQ 250	168,5	MP(F)E 250	180,0	MPQE 250	186,0	33,33
MP(F) 315	171,5	MPQ 315	178,0	MP(F)E 315	189,0	MPQE 315	195,5	42,67
MP(F) 400	182,0	MPQ 400	188,5	MP(F)E 400	200,0	MPQE 400	206,0	53,33
MP(F) 500	195,5	MPQ 500	202,0	MP(F)E 500	213,0	MPQE 500	219,5	66,63
MP(F) 630	213,0	MPQ 630	219,0	MP(F)E 630	230,5	MPQE 630	236,5	84,00

SHAFT EXTENSIONS FOR MP AND MR MOTORS

C - $\phi 25$ straight, Parallel key A8x7x32 DIN 6885
Max. Torque 34 daNm

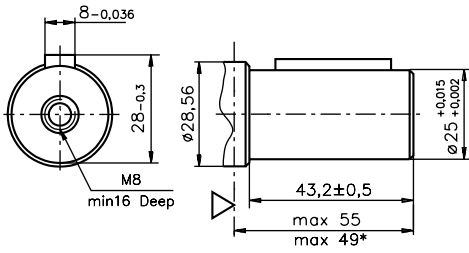

CB - $\phi 32$ straight, Parallel key A10x8x45 DIN 6885
Max. Torque 77 daNm

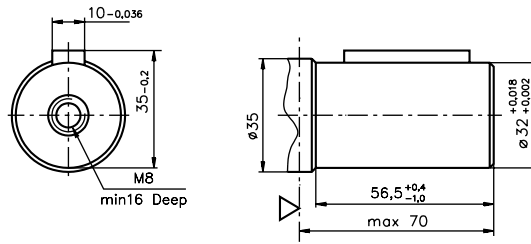

CO - $\phi 1"$ straight, Parallel key $1/4"x1/4"x1/4"$ BS46
Max. Torque 34 daNm

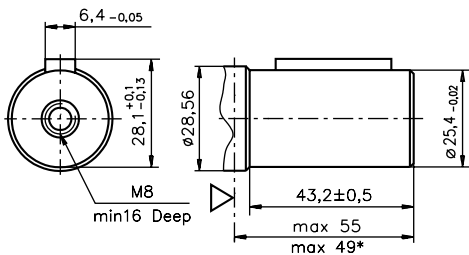

SB - splined A25x22xH10 DIN 5482
Max. Torque 34 daNm

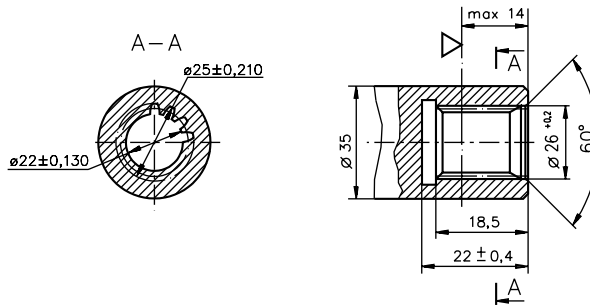

SH - splined, BS 2059 (SAE 6B)
Max. Torque 40 daNm

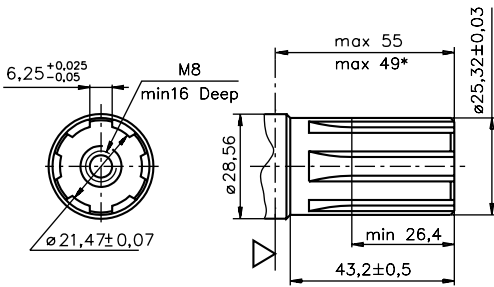

KB - tapered 1:10, Parallel key B6x6x20 DIN 6885
Max. Torque 77 daNm

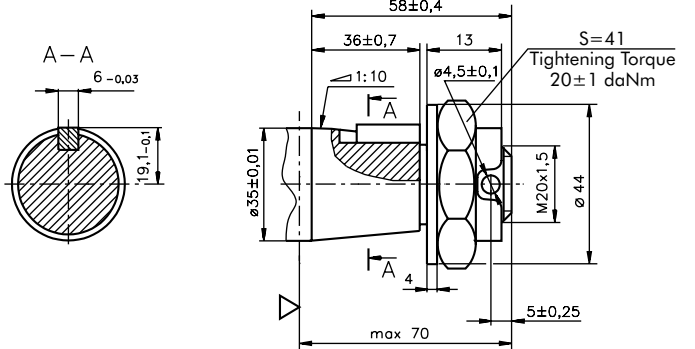

K - tapered 1:10, Parallel key B5x5x14 DIN 6885
Max. Torque 40 daNm

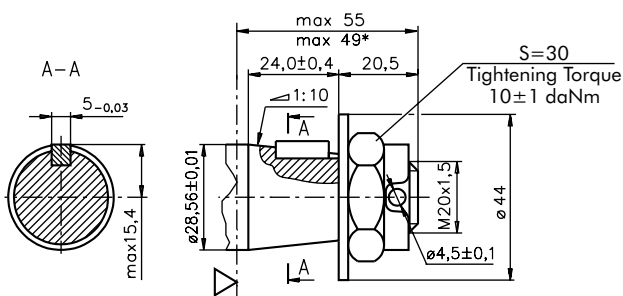

OB - tapered 1:8 SAEJ 501, Parallel key $5/16"x5/16"x1/4"$ BS46
Max. Torque 77 daNm

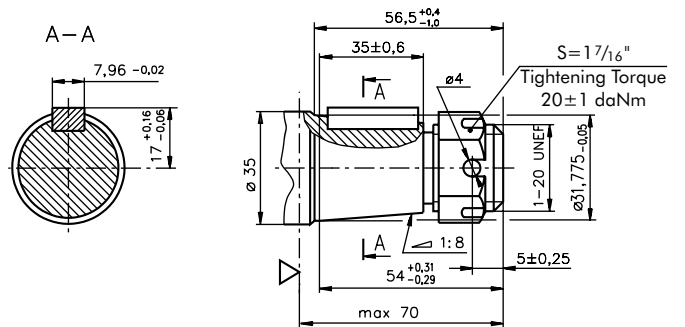

SA - splined, B25x22h9 DIN 5482
Max. Torque 40 daNm

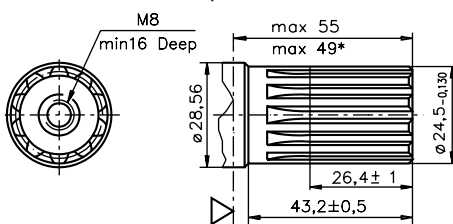

HB - $\phi 1 1/4"$ splined 14T, ANSI B92.1-1976 Norm
Max. Torque 77 daNm

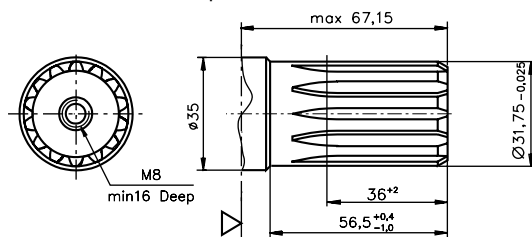

▽ - Motor Mounting Surface

* - For Q-flange

PERMISSIBLE SHAFT LOADS FOR MP AND MR MOTORS

The permissible radial shaft load P_{rad} depends on the speed (RPM) and distance (L) from the point of load to the mounting flange.

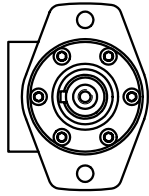
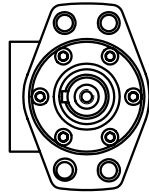
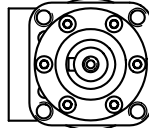
Mounting Flange			
Shaft Version	cylindrical - C, CO tapered - K, splined - SH	splined - HB cylindrical - CB	cylindrical - C, CO
Radial Shaft Load P_{rad}^*	$\frac{800}{n} \times \frac{25000}{95+L}$, daN	$\frac{800}{n} \times \frac{18750}{95+L}$, daN	$\frac{800}{n} \times \frac{25000}{101+L}$, daN

$n < 200 \text{ min}^{-1}$; max $P_{rad} = 800 \text{ daN}$

* $n \geq 200 \text{ min}^{-1}$; $L < 55 \text{ mm}$

MPN and MRN

MP and MR

The curves apply to a B10 bearing life of 2000 hours.

- 1: Max. radial shaft load
- 2: $n = 50 \text{ min}^{-1}$
- 3: $n = 200 \text{ min}^{-1}$
- 4: $n = 800 \text{ min}^{-1}$

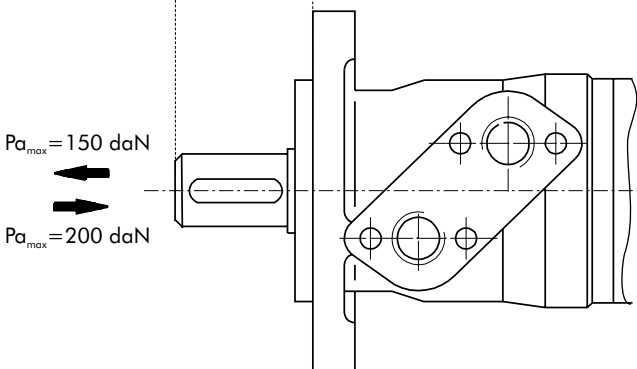
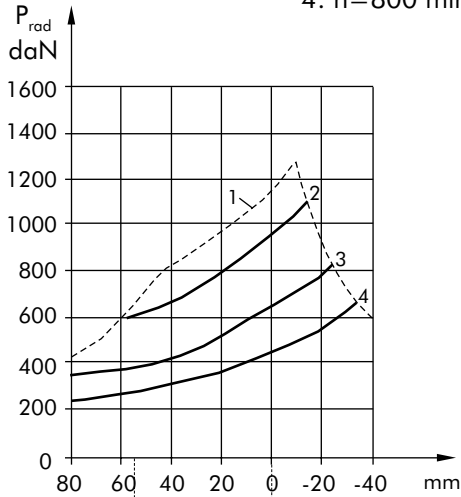

Radial Shaft Load P_{rad} for C, CO Shaft Extensions by $L = 30 \text{ (24) mm}$

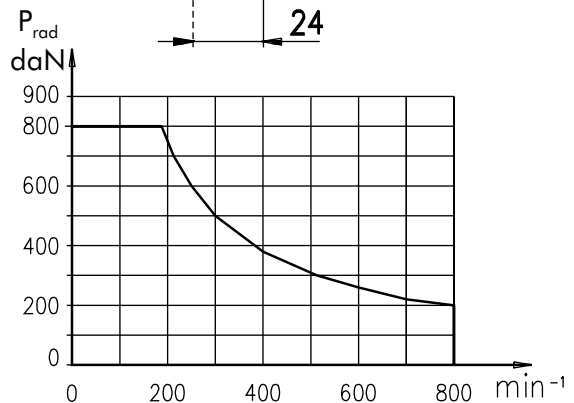
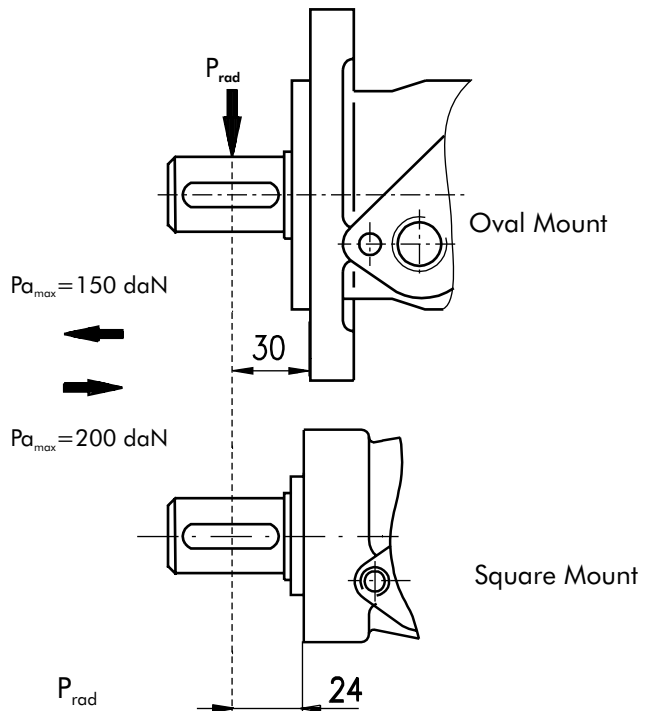

MAX. PERMISSIBLE SHAFT SEAL PRESSURE FOR MP AND MR MOTORS

MP/MR...U1 motors with high pressure seal and without drain connection:

The shaft seal pressure equals the average of input pressure and return pressure.

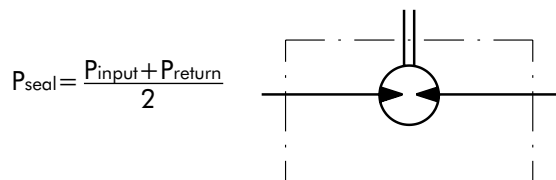

MP/MR...U motors with high pressure seal and drain connection:

The shaft seal pressure equals the pressure in the drain line.

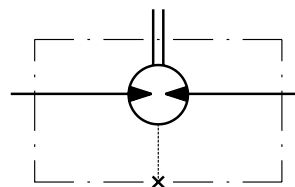

MP/MR...1 motors with low pressure seal or standard shaft seal and without drain connection:

The shaft seal pressure never exceeds the pressure in the return line.

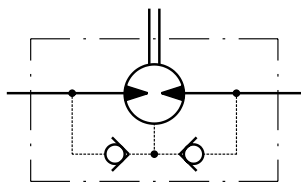

MP/MR... motors with low pressure seal or standard shaft seal and with drain connection:

The shaft seal pressure equals the pressure in the drain line.

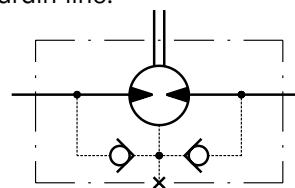

Max. return pressure without drain line or max. pressure in the drain line

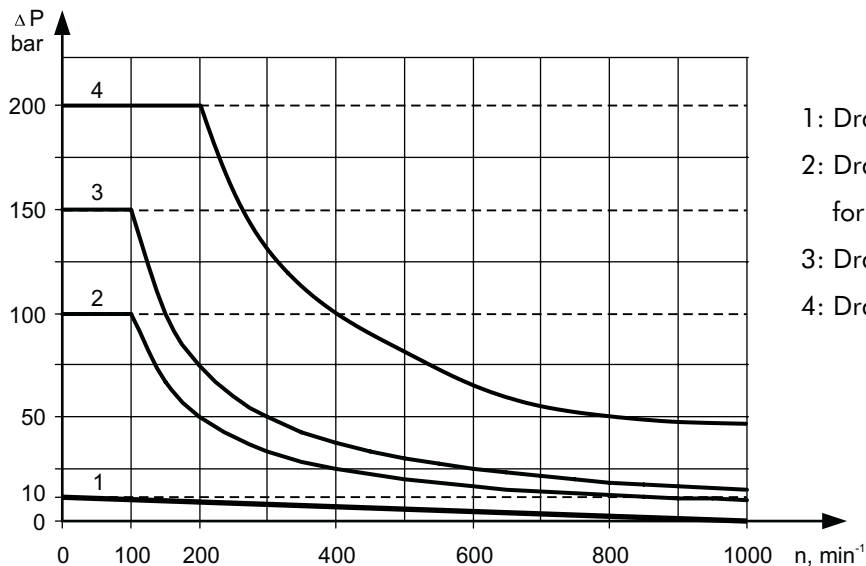

- 1: Drawing for Low Pressure Seal
- 2: Drawing for Standard Shaft Seal for "...B" shafts
- 3: Drawing for Standard Shaft Seal ("D" Seal)
- 4: Drawing for High Pressure Seal ("U" Seal)

— - continuous operations
- - - - intermittent operations

MP
MOTORS

ORDER CODE

	1	2	3	4	5	6	7	8	9	10
M P										

Pos.1 - Mounting Flange

omit - Oval mount, two holes

F - Oval mount, four holes

Q - Square mount, four bolts

W - Wheel mount

Pos.2 - Option (needle bearings)

omit - none

N - with needle bearings

Pos.3 - Port type

omit - Side ports

E - Rear ports

Pos.4 - Displacement code

25* - 25,0 [cm³/rev]

32* - 32,0 [cm³/rev]

40* - 40,0 [cm³/rev]

50 - 49,5 [cm³/rev]

80 - 79,2 [cm³/rev]

100 - 99,0 [cm³/rev]

125 - 123,8 [cm³/rev]

160 - 158,4 [cm³/rev]

200 - 198,0 [cm³/rev]

250 - 247,5 [cm³/rev]

315 - 316,8 [cm³/rev]

400 - 396,0 [cm³/rev]

500 - 495,0 [cm³/rev]

630 - 623,6 [cm³/rev]

Pos.5 - Shaft Extensions (see page 24)**

C - ø25 straight, Parallel key A8x7x32 DIN6885

VC - ø25 straight, Parallel key A8x7x32 DIN6885 with corrosion resistant bushing

CO - ø1" straight, Parallel key ¼"x¼"x1¼" BS46

VCO - ø1" straight, Parallel key ¼"x¼"x1¼" BS46 with corrosion resistant bushing

SH - ø25,32 splined BS 2059 (SAE 6B)

VSH - ø25,32 splined BS 2059 (SAE 6B) with corrosion resistant bushing

K - ø28,56 tapered 1:10, Parallel key B5x5x14 DIN6885

SA - ø24,5 splined B 25x22 DIN 5482

VSA - ø24,5 splined B 25x22 DIN 5482 with corrosion resistant bushing

CB - ø32 straight, Parallel key A10x8x45 DIN6885

KB - ø35 tapered 1:10, Parallel key B6x6x20 DIN6885

SB - splined A 25x22 DIN 5482

OB - ø1¼" tapered 1:8, Parallel key 5/16"x5/16"x1¼" BS46

HB - ø1¼" splined 14T ANSI B92.1 - 1976

Pos. 6 - Shaft Seal Version (see page 26)

omit - Low pressure shaft seal or Standard shaft seal for "...B" shaft

D - Standard shaft seal

U - High pressure shaft seal (without check valves)

Pos. 7 - Drain Port

omit - with drain port

1 - without drain port

Pos. 8 - Ports

omit - BSPP (ISO 228)

M - Metric (ISO 262)

Pos. 9 - Special Features (see page 46)

Pos.10 - Design Series

omit - Factory specified

* Not with Low Pressure Seal

** The permissible output torque for shafts must not be exceeded!

NOTES: The following combinations are not allowed: - **Q** flange with "...B" shafts;
- **W** flange with "...B" shafts, **U** option or **E** rear ports;
- **N** option with "...B" shafts, Low Pressure Seal or **U** option;
- "...B" shafts with **D** and **U** shaft seals.

The hydraulic motors are manganophosphatized as standard.